



MAX

MV240-BT

HARDCORE CAR AUDIO

WE PLAY LOUD!!

We know what you want. You want it LOUD, and that's exactly what we do, what we live for. Vibrations, gut-punches and straight up loud music - that's what makes us tick. We won't dress up in fancy words or claim to be something we're not. We are the NO BULLSH!T car audio brand!











Every single product with the GAS logo on it is born out of passion, the same that has driven us for two generations and that will keep us rolling up to your neighbourhood, winning and pushing the limits for many generations to come!

It's up to you to choose your own level of loud, and if you don't like what we do that's OK. You are welcome back when you've had your first true GAS experience. We don't exclude, we don't judge and we do not make up any excuses for who we are.

We are GAS and we are proud to be LOUD!

GAS

TABLE OF CONTENT

 SAFETY.....	3
 UNPACKING.....	5
 DIMENSIONS.....	5
 SPECIFICATIONS.....	6
 FUNCTIONS.....	8
 HOW TO.....	9
Basic operations.....	9
Setting date/time.....	10
Equalizer.....	10
Fader/Balance/Subwoofer.....	11
FM/AM radio.....	11
Apple CarPlay.....	15
Phonelink.....	16
Playback.....	18
Bluetooth.....	19
Steering Wheel Control.....	21
Additional devices.....	21
Reset the unit.....	21
Replace a fuse.....	21
 SETTINGS.....	22
General.....	22
Video.....	22
Time.....	23
System.....	23
Volume.....	23
 TROUBLESHOOTING.....	24
No power.....	24
Unwanted noise.....	24
Distortion.....	24
No video.....	24
 WARRANTY & DISPOSAL.....	25
 THE GAS WORLD.....	26



SAFETY

NO COMPROMISES! Especially when it comes to safety. Before installing your MAX head unit, make sure that you read through the manual thoroughly and follow the instructions. Save the manual for future usage and reference!

Make sure to pay attention to the instructions when you see this symbol: 

Make sure that your vehicle has a 12 VDC voltage negative ground system, that it can handle an increased power consumption, and that both the alternator and the power source are healthy and up to the task.

Do not install the head unit where it may be exposed to dirt, excessive damp or moisture. If the head unit is exposed it might result in electric failure, shock or damage to the product. Your head unit will produce heat so make sure it'll have sufficient air circulation. Servicing is required when the product has been damaged in any way and /or doesn't operate normally. Refer all servicing to qualified service personnel only.

Keep the cables inside the vehicle separate from sharp edges or components that may be affected or take damage. Follow the recommended cable sizes and always use high quality cables and accessories. Even if you're eager to put the head unit to use - take no shortcuts when installing the unit, make sure that all connectors are protected and secured.

Don't drill any holes without checking what lies beneath, and don't cut anything without making sure that no important components risk being damaged.

There's a first time for everything, if you need help - ask a friend or contact your local GAS AUDIO POWER dealer/installer.

We want you to experience your products to the MAX, but we don't want you to injure yourself or others. Use common sense, respect high pressure levels and volume, and follow your local laws and regulations.



SAFETY

DETECT PARKING BRAKE

To make sure that traffic safety is met, video playback is disabled in the head unit when you are driving. When the parking brake is in use, the video playback function is accessible. For proper installation and usage of the head unit, the following connection must be made:

- Connect the cable "PARKING" to the parking brake switch to view video files on the TFT monitor. Engage the parking brake to unlock the video viewing function.
- When the parking brake is not engaged, the monitor will display a message: *"Warning!! Video playback is disabled for your safety. Engage parking brake to watch video"*. This setting does not affect rear viewing connected to a rear view camera.

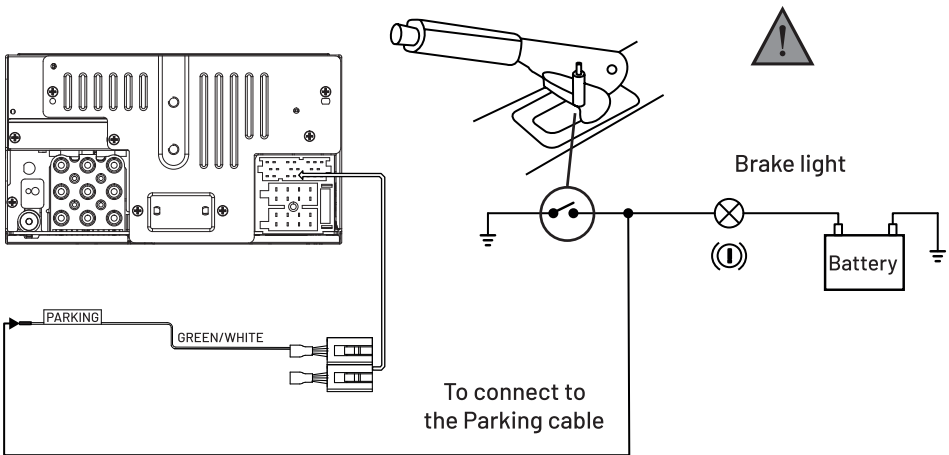

UNPACKING

We know you're excited to dive head first into installing your new head unit, but before you do: Make sure that the head unit and all the accessories are included in the packaging.

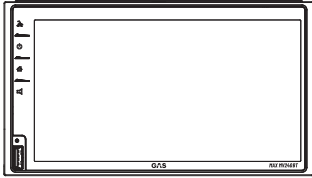

Head unit

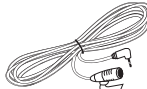

Microphone

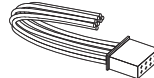

ISO connection
(2 pcs)

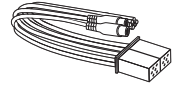

Video/SWC
connection



Manual

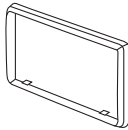

Trim panel

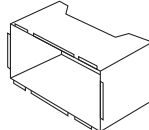

Mounting
sleeve

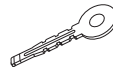

Removal keys
(2 pcs)



USB extender

DIMENSIONS

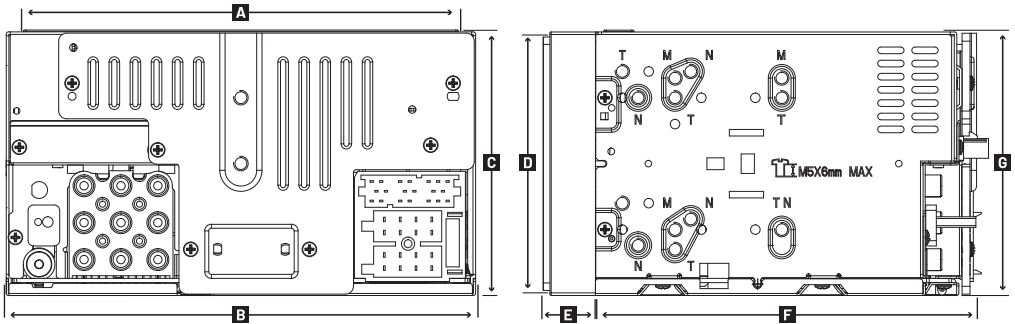

	A	B	C	D	E	F	G	
MV240-BT	170	178	100	96	20	145	100	mm

SPECIFICATIONS

We take pride in our work! Listening, measuring and engineering are essential parts in our workshop. That's how we make sure to bring you an awesome product with NO BULLSH!T.

GENERAL

Power source	14.4V (11-16V)
Grounding	Negative type
Maximum current consumption	15A
Operational temp.	-10°C to +60°C
Weight (net)	1.9KG
Backlight type	LED
Illuminated buttons	White or red
Touch screen panel	Capacitive type
Screen size	6.75"
Aspect ratio	16:9
Panel resolution	1024x600
Brightness	400-450 lumen
2V pre-outs 3 pair	Front, Rear, Sub
24-bit DAC	Yes
Firmware updates	Via USB-port
Clock / date	Yes / Yes
Memory backup	Yes
App control	No
Steering wheel remote	Compatible
Remote control	Not compatible
Power antenna lead	+12V to external amp. or electric antenna

USB / MicroSD

USB standard	USB1.1, USB 2.0
File system	FAT12/16/32
Maximum supply current	DC 5V=1.5A
Frequency response	20Hz-20kHz (± 3dB)
Total harmonic distortion	0.2% (1kHz)
Signal to Noise ratio	80dB (1kHz)
Channel separation	60dB (1kHz)
MP3 decode	Compliant with MPEG1/2 Audio Layer3

BLUETOOTH

Version	BT 4.2
Bluetooth frequency range	2402GHz-2480GHz
RF output power (E.I.R.P.)	4dBm (MAX), Power Class2
Maximum communication range	Line of sight, approx 10m
Profile	HFP1.7.1 (Hands Free Profile)
	A2DP PBAP
	AVRCP
	Serial Port Profile

SPECIFICATIONS

AUDIO

MAX output power	4x45W
Full bandwidth power (at less than 1%THD)	4x25W
Speaker impedance	4- 8 Ohm
Pre-out level	2000mV / 10kOhm load
Frequency response	20Hz-20kHz (± 3dB)
Pre-out impedance	> 100 Ohm

AUX

Frequency response	50Hz - 20kHz (± 3dB)
Input MAX voltage	500mV
Input impedance	30kOhm

FM RADIO

Frequency range	87.5MHz-108MHz (50kHz step)
Usable sensitivity	3dB (S/N=23dB)
S/N ratio (mono)	MNO 1MV 55dB
Frequency response	40Hz - 12kHz (± 3dB)
Stereo separation	>25dB (1kHz)

AM RADIO

Frequency range	522kHz-1620kHz (50kHz step)
-----------------	--------------------------------

AUDIO SETTINGS

Equalizer 13-band	62.5Hz, 100Hz, 160Hz, 250Hz, 400Hz, 630Hz, 1kHz, 1.6kHz, 2.5kHz, 4kHz, 6.3kHz, 10kHz, 16kHz
Presets	Comfort, Jazz, Classic, Rock, Pop & Powerful
Fader / Balance	Yes / Yes
Loudness	Yes
Subwoofer level adjustment	+12 to -12 steps

FUNCTIONS

NO COMPROMISES - that's the spirit of the MAX series. The MAX head units are made for the enthusiasts out there who crave high precision audio! We've packed the head unit with a bunch of interesting features. We know you're itching to get your new sound system going, but make sure to read through these pages - so you can get the most out of your setup!

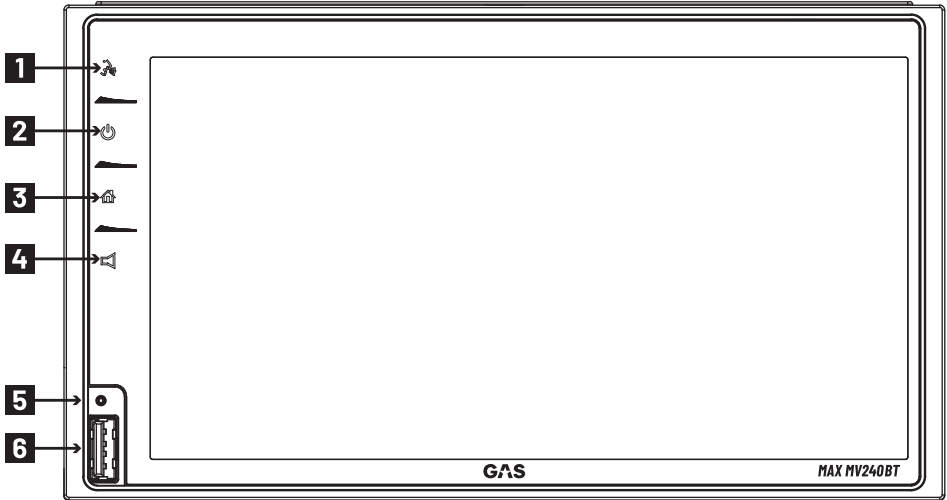

1 VOICE CONTROL

Press to activate Siri voice control.

2 ON/OFF

Short press: Switch on display.
In operation: Mute audio source.
Long press: Switch off display.

3 HOME

Go to the main menu.

4 VOLUME

Show & adjust the volume.

5 RESET BUTTON

Press to reset system settings to factory default.

6 USB PORT

Connect USB device for playback of music/video/picture files.

HOW TO

A well-built sound system will set you aside from the rest and elevate your vehicle! It's important that you carefully read the instructions on the following pages. This is to make sure that you use the head unit correctly, for the true MAX EXPERIENCE!

BASIC OPERATIONS

POWER ON / OFF

Press the [] button on the unit to turn the display on. The buttons on the front of the unit light up and the current mode status appears in the LCD.

Press and hold the [] button to power off the display.

VOLUME ADJUSTMENT

You can adjust the volume in steps from 0 (off) to 39 (maximum).

Press the [] button and drag left/right on the volume bar to change the volume.

MUTE

Briefly press the [] button to mute the device or to reactivate the previous volume.

PLAYING SOURCE SELECTION

Press the [] button on the front panel to display the playing source menu.

The playing mode is displayed on the screen.

1. USB
2. AV IN
3. EQ
4. DISPLAY OFF
5. SETTINGS



HOW TO

SETTING DATE/TIME

1. Touch [Settings].
2. Touch [Time].
The date/time setup menu is displayed.



SET DATE

1. Touch [Date].
2. Touch the date information on the screen .
A submenu is displayed.
3. Scroll [Up] or [Down] to set year, month and day.
4. When date is set, touch [OK] to confirm or [Cancel] to exit.

SET CLOCK MODE

1. Touch [Clock mode].
2. Touch [12Hr] or [24Hr] to switch clock mode.

SET TIME

1. Touch [Time].
2. Touch the time on the screen, a submenu is displayed.
3. Scroll [Up] or [Down]
4. When time is set, touch [OK] to confirm or [Cancel] to exit.

EQUALIZER

The Audio Control feature allows you to easily adjust your audio system to meet the acoustical characteristics of your vehicle, which vary depending on the type of vehicle and its measurements. Proper setting of the Fader and Balance boosts the effects of the cabin equalizer.

SELECT PRESET

1. Enter the EQ setup mode
Touch the [] icon in the user interface and the EQ setup interface will display on the screen.
2. Select EQ mode
Touch the desired EQ selection: [Comfort] / [Classic] / [Rock] / [Jazz] / [Pop] / [Powerful], and the EQ mode will change.



ADJUST EQUALIZER PARAMETERS

To adjust EQ parameters, touch and drag the parameters adjustment bar.

[Customize]: Set the desired audio effect.













[Original]: Select the original audio effect.

[Loudness: On/Off]: When listening to music at low volumes, this feature will selectively boost certain bass and treble frequencies.

HOW TO

FADER / BALANCE / SUBWOOFER

You can adjust the fader control from front to back and the balance control from left to right of the speakers. You can also adjust subwoofer volume to get your listening experience just like you want.

1. Enter the EQ setup mode
Touch the [] icon in the user interface and the EQ setup interface will display on the screen.
2. Adjust subwoofer volume
Touch []/[] or drag [] to adjust the subwoofer volume from -12 to +12.
3. Adjust fader / balance value
Touch []/[]/[]/[] to adjust fader / balance value from -7 to +7.
[]: Front speaker
[]: Rear speaker
[]: Left speaker
[]: Right speaker

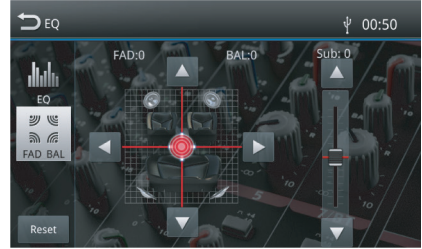

Notes:

1. The parameters of the EQ modes has been preset and you can not change them besides 'User'.
2. The EQ mode will change to 'User' automatically when you adjust the frequency value under the modes besides 'User'.
3. The value of Sub is independent of EQ mode and can be adjusted separately.

FM/AM RADIO

BUTTON OVERVIEW (PART 1)

1. Touch to view the MENU and select a new source
2. Current radio frequency
3. Clock
4. Tune back (short press)
Search back (long press)
5. Tune forward (short press)
Seek forward (long press)
6. Broadcaster information stored at the preset
7. Touch to change between AM/FM bands
8. Search stations automatically
9. View all stored stations
10. Enter frequency directly
11. View more on-screen buttons



HOW TO

BUTTON OVERVIEW (PART 2)

12. RDS setting options
13. Save the desired radio station
14. Touch to change between Local and Distance
15. Touch for quick access to EQ level settings

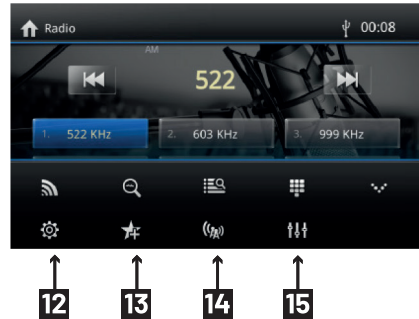

SELECT RADIO AS PLAYING SOURCE

Open the Source Menu and then touch [Radio].

SELECT ONE RADIO BAND

Touch the [] icon on the user interface to change between the radio bands FM & AM. Swipe the screen left/right to cycle through the bands.

TUNE THE RADIO

Auto Tuning



During auto tuning, the frequency will be changed in seek mode.

Touch the [] / [] icon on the user interface to tune in a higher / lower station.



Note: When a station is received, searching stops and the station is played.

Manual Tuning

Method 1:

Touch and hold [] / [] icon on the user interface more than 1 second to changed in steps higher / lower station. Repeat the operation to change step by step.

Method 2:

1. Touch the numeric keypad icon (9) [].
Numeric keyboard is displayed, touch number to write frequency numbers. (10280 = 102.80 Mhz)
2. Touch [] to delete the written frequency numbers step by step.
3. Touch [OK] to enter.

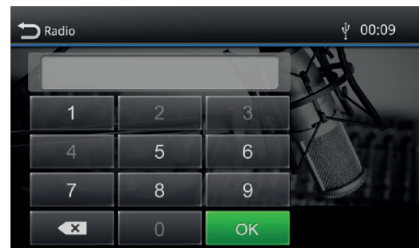

HOW TO

PRESET STATION

The unit has 5 bands, such as FM1, FM2, FM3, AM1, AM2, and each band can store 6 stations; the unit can store 30 stations in total.

Search Stations Automatically

Touch [] to search station and store 6 strongest stations in current band automatically.

Manual Store

1. Tune to a station manually.
2. Touch [].
3. Touch one of the channels P1 to P6 to save the selected station.

Tune to a Preset Station

1. Touch [].
2. Touch one of the preset channels on the screen.

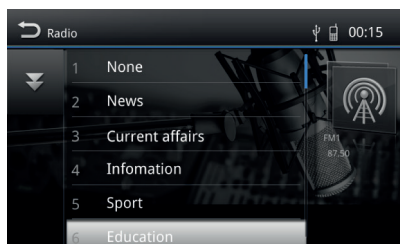

ADJUSTING THE SEEK TUNING SENSITIVITY

The seek tuning sensitivity decides whether the automatic station seek tuning finds only strong stations or also weaker stations that may be noisy. Press the button [] to adjust the sensitivity of station seek tuning. If LOC is on, only stations with a strong signal are found during tune searching. If LOC is off, stations with both strong and weak signals are found during tune searching.

EQ SELECTION

Press the [] icon and enter the EQ setup.

RDS BASICS

RDS transmits data to the radio which displays information such as station name, artist and song title. RDS service availability varies with areas.

ADJUST RDS SETTINGS

1. In Radio menu, touch [].
The option menu is displayed.
2. Touch on the selected option to change the setting.
[RDS]: To turn on or off "RDS" function.
[CT]: To turn on or off "Clock Time" synchronization.
[TA]: To turn on or off "TA" function.
[PTY]: To show PTY list.
[EON]: To turn on or off "EON" function.

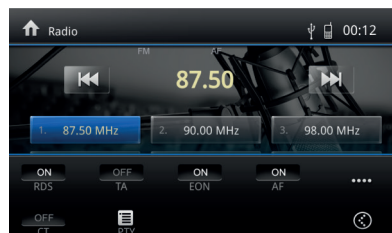

HOW TO

PRESET STATION

The unit has 5 bands, such as FM1, FM2, FM3, AM1, AM2, and each band can store 6 stations; the unit can store 30 stations in total.

RDS (RADIO DATA SYSTEM)

The unit provides basic functions of RDS.

RDS service availability varies with areas. Please verify if RDS service is available in your area.

AF FUNCTION

Alternative Frequencies lists are used in conjunction with the PI code (Program Identification code) to assist automatic tuning. Using this information, the radio can automatically search out another frequency of the same station.

Note:

- During auto switching radio frequency, some interference may be heard.
- Turning off AF function can settle this problem.

TA FUNCTION

The TA (Traffic Announcement) function lets the unit receive traffic announcements automatically. The TA function can be activated by a TP (Traffic Program) station broadcasting traffic information. When TA is activated and a traffic announcement is received, the current playing source will be overridden by the traffic announcement. The unit returns to the original source after the traffic announcement has been received.

CT (CLOCK TIME)

Some stations broadcast the time and date within the encoded RDS signal. The clock time is automatically adjusted when 'CT' is set to 'ON'.

PTY FUNCTION

PTY is an abbreviation for the type of program defined by a code to define the program being broadcast (eg news or Rock).

The Options of PTY is displayed on the screen. To see the options PTY, tap the scroll bar and arrows on the screen.

When an option is selected PTY (eg News), the radio unit, the PTY search available. If the PTY requested was not found, the unit returns to the original radio frequency.

EON (ENHANCED OTHER NETWORKS)

EON will tell the radio about any traffic bulletins being broadcast by stations in the local area

HOW TO

APPLE CARPLAY

Use an apple lightning cable to connect an iPhone with the product, and it will automatically show the CarPlay interface. User could directly operate the common functions of iPhone on the product. iPhone support: minimum iPhone5; Required iOS: minimum iOS 7.1.

NOTE! Only use front USB socket for Carplay!



PLAY MUSIC

When in the CarPlay menu, press the music icon to access all of your content from iTunes.

CALL OUT / RECEIVE CALL

When in the CarPlay menu, press the phone icon to access your contacts and make a phone call. If you are receiving a phone call, the display will notify you and give you the option to answer or ignore the incoming phone call.

USE MAP / GPS

When in the CarPlay menu, press the map icon to access the maps / GPS function. Touch the function "Destinations" to browse your previous destinations or enter an address and press accept to activate the GPS and receive directions.

MESSAGE

When in the CarPlay menu, press the message icon to listen to your unread messages or send a message to one of your contacts.

SIRI VOICE CONTROL

1. Touch and hold the Apple Home key on your iPhone to activate the Siri voice assistant. It can be used for issuing a call, playing music, opening the map and other commands.
2. Activate Siri voice assistant by saying "Hey, Siri" loud and clear.

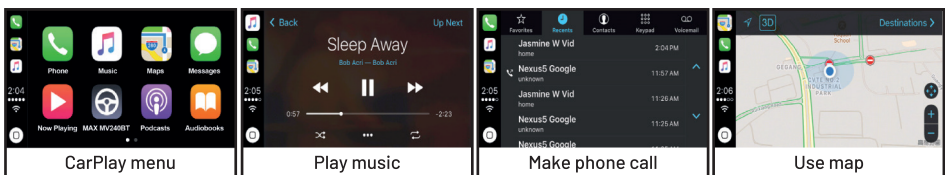

HOW TO

PHONELINK

Phonelink gives you the function to interconnect information between your smartphone and the car's multimedia player.

With Phonelink you can synchronize the display screen from your smartphone to the head unit, and also control your phone via the head unit's touchscreen in the car. For example, you can receive calls, dial calls, listen to music and watch movies or pictures from your phone directly on the head unit. You can also use navigation apps via your smartphone to the head unit to get maps and directions displayed on the head unit's screen.



NOTE! Only use the head unit's front USB socket for Phonelink!

The function of the Phonelink depends on the configuration of your smart phone. Open the Main Menu and touch [Phonelink] to enter Phonelink mode.



CONNECT WITH ANDROID PHONE

1. Correctly connect your phone to the unit by USB wire. (Original Data USB Cable Recommended).
2. Have the Autolink App installed on your smartphone (the App name is Autolink, not Phonelink).
3. After a connection's been made, operate according to the screen software.

TIP:

- For your driving safety, please do not use the function while driving.
- Due to variations in the performance and standard features of smartphones, the performance of the Phonelink function may vary with each individual brand of smartphone.

NOTE! Some video-streaming services may not work due to HDCP.

HOW TO

PLAYBACK

TOUCH SCREEN CONTROLS

The touch key areas for playback are outlined below:

- A: Return to the main menu
- B: Display onscreen control menu
- C: Time display

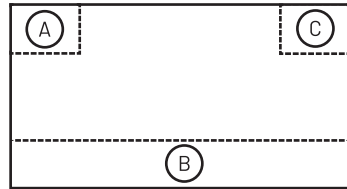

CONTROLLING PLAYBACK

To access the on-screen controls, touch the screen except upper left corner, and touch again to cancel display. Touch [••••] to view all function icons.

CONNECT A USB DEVICE

1. Insert the USB socket, then connect the other end of the cable to your USB device.

REMOVE A USB DEVICE

1. Select other source on the main menu.
2. Remove the USB device.

PLAY/PAUSE

1. Once USB is inserted, play starts automatically.
For movie, if a menu appears, press [▶] to start play.
2. To pause, touch [||].
To resume play, touch [▶].
3. Skip to previous / next track / chapter, press [⏮] / [⏭] key.

PREVIOUS/NEXT

Touch [⏮] / [⏭] key on the screen to skip to previous / next track / chapter.

HOW TO

SEARCH FOR CONTENT

For Folder Control

1. Touch [] to display all available folders
2. Touch a folder, then touch the desired file.
3. Touch the file again to start play

For Audio Files

1. Touch [] to display all available audio folders.
2. Touch a folder, then touch the desired file.
3. Touch the file again to start play.

For Video Files



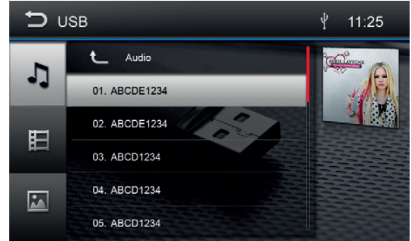

1. Touch [] to display all available video folders.
2. Touch a folder, then touch the desired file.
3. Touch the file again to start play.

For Picture Files

1. Touch [] to display all available picture folders
2. Touch a folder, then touch the desired file.
3. Touch the file again to start play.





REPEAT



1. Touch anywhere except the upper left corner to display menu on the screen.
2. Touch [] repeatedly:
 - [] Repeat off: Cancel repeat play.
 - [] Repeat folder: Play all in the current folder.
 - [] Repeat single: Play the current single repeatedly.

SHUFFLE (RANDOM) PLAY



You can play audio tracks/files in random order.

1. Touch [] to display the 2nd menu.
2. Touch [] on the screen repeatedly to turn random play on or off.

ROTATE PICTURES

1. When you view pictures, touch the screen to display menu on the screen, if necessary.
2. Touch [] to display the 2nd menu.
3. Touch [] or [] repeatedly to rotate the picture.

ZOOM IN OR OUT

1. When you view pictures, touch the screen to display menu on the screen, if necessary.
2. Touch [] to display the 2nd menu.
3. Touch [] or [] repeatedly to zoom in or out the picture.

HOW TO

BLUETOOTH

You can make or receive phone calls and listen to music with Bluetooth-enabled phones or devices through the head unit.

BLUETOOTH DEVICE

- In the main menu, press the phone icon and the Bluetooth menu will be displayed. The list shows known Bluetooth devices.

[📶] Add a new Bluetooth device.

[⚙️] Displays the settings menu.

- Press the [📶] key of the Bluetooth device with which you want to establish a connection. When the device is within range and the connection is established, the device is displayed in the menu.
- Press the [🗑️] key if you want to delete the chosen Bluetooth device from the list.



CONNECTING BLUETOOTH DEVICES

If you want to connect a device to the audio system for the first time, do the following:

1. Activate the Bluetooth function on the device.
2. Touch [📶] to search for the Bluetooth device with the unit.
3. Start scanning on the Bluetooth device and select the unit "MAX MV240BT"

The connection is established and the menu for the registered device is displayed.

Note:

- If a telephone is connected with the car sound system, the Bluetooth icon is displayed at the right edge of the display in all audio/video sources.
- When a phone book is synchronized with the unit, there may be some intermission in the music playback.

BLUETOOTH FUNCTIONS

[🌟] Show favorites.

[📁] Call up the phone book.

[📄] Call up records lists.

[📱] Display the dial keypad menu.

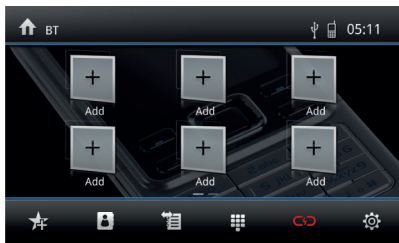

[🔗] Disconnect connection with current device.

[⚙️] Display options menu.





HOW TO

MAKE A CALL

- Enter a phone number with the dial keypad and press the [] button. 00[46][70000000] (Swedish number) - Or -
- Select a contact/number via the records lists or phone book. The connection is being established. If a call is coming in, the call menu is displayed.
[] (Hang up): Reject a call.
[] (Answer): Answer a call.







ALPHABETIC SEARCH

Press [] on the left bottom of the screen to access Phonebook. If you want to search a contact, press [] and enter the characters via the keypad.

AUDIO PLAYBACK VIA BLUETOOTH STREAMING

A2DP is short for Advanced Audio Distribution Profile. The mobile phones supporting this function can transmit stereo audio, whereas the ones not supporting this function can transmit mono audio only.

- Press the [BT music] button in the main menu to change to the audio playback.
[] Title selection.
[] Interrupt playback and continue playback.
[] Title selection.
[] Enter the EQ setup menu.
[] Disconnect connection with current device.

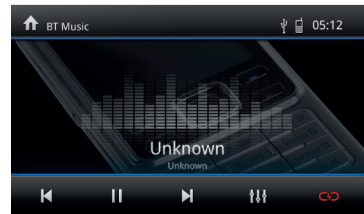

BLUETOOTH SETTINGS

- Press the [] button.
The options menu is displayed.
[Auto Connect]: The unit automatically connects to the Bluetooth devices listed in the head unit.
[Auto Answer]: Incoming phone calls are auto-answered.
[Phone book sync]: To be able to access the phonebook of the connected phone, synchronization (Bluetooth settings in the mobile phone) is required



HOW TO

STEERING WHEEL CONTROL

The following settings may vary depending on car brand/model and which kind of steering wheel control adapter interface that is used.

1. Touch the [] button in main menu.
2. Touch [General setting] in the settings page.
3. Touch [SWC], the SWC menu will display.
4. Select the keys corresponding to the functions of steering wheel controls by tapping the KEY and set desired function.
5. Touch [Match] to program.
6. Press each individual steering wheel control button for each corresponding function.
7. Once the final steering wheel control button is programmed, the functions are saved and the programming finished.
8. Touch [Reset] to reset the programming to original settings.

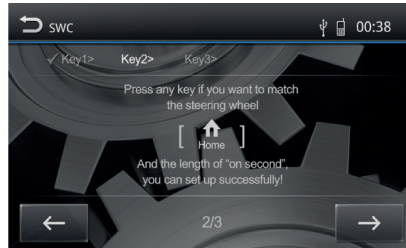

ADDITIONAL DEVICES

You can connect an external audio/video device to the unit.

1. Connect the external device with the supplied AV cable (Video), AUX-in (sound) connects at AUX-input in the chassis connections.
2. Touch the upper left corner to display the main menu.
3. Touch [AV-IN] to access external device.

RESET THE UNIT

If you are experiencing technical difficulties with your head unit, for example if the program shuts down or a functions freezer/ glitches, you can try to solve the problem by doing a reset.

1. Press [RESET] with a ball-point pen or similar tool.

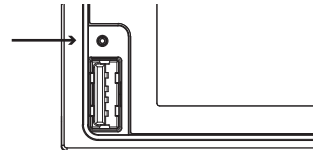

REPLACE A FUSE

If there is no power, the fuse may be damaged and need to be replaced.

1. Remove the unit from the dashboard.
2. Check all electrical connections.
3. Buy a fuse that matches the amperage (15A) of the damaged fuse.
4. Replace the fuse while the unit is powered off.

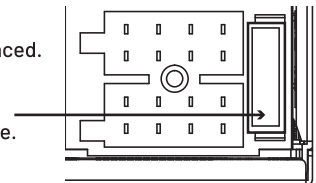

SETTINGS

GENERAL

1. Touch [General] in the settings page.
2. Touch to highlight a setting.
3. Touch to display/select an option.

MENU SETTING	FUNCTION	VALUES
[SYSTEM LANGUAGE]	Select display language.	ENGLISH
[LIGHTING]	Choose color on the display text and buttons.	WHITE, RED
[RADIO REGION]	Select your region of origin.	EUROPE, NORTH AMERICA, SOUTH AMERICA, JAPAN
[BEEP]	Makes a beep sound every time you press a button.	OFF, ON
[SWC]	Steering Wheel Control. It lets you control the head unit via buttons on the car's steering wheel.	OFF, ON
[Local]	Search through the radio stations that only have a strong signal.	OFF, ON

VIDEO

1. Touch [Video] in the settings page.
2. Touch an option repetadly to select it.
3. Touch the upper left corner of the screen to exit.

MENU SETTING	FUNCTION	VALUES
[BRIGHNESS MODE]	Preventing the display from being too bright at night.	DAY, NIGHT, AUTO
[BRIGHTNESS]	Adjust display brightness.	1, 2, 3, 4, 5, 6, 7, 8, 9, 10



SETTINGS

TIME

1. Touch [Time] in the settings page.
2. Touch an option repetadly to select it.
3. Touch the upper left corner of the screen to exit.

MENU SETTING	FUNCTION	VALUES
[SET DATE]	Change date on the display.	YEAR,MONTH, DAY
[SET TIME]	Change time on the display.	HOUR, MINUTE, AM, PM
24H FORMAT]	Chose 24 hour time display.	OFF, ON

SYSTEM

1. Touch [System] in the settings page.
2. Touch an option repetadly to select it.
3. Touch the upper left corner of the screen to exit.

MENU SETTING	FUNCTION	VALUES
[MCU UPDATE]	Update the MCU software.	SELECT
[MPEG UPDATE]	Update the MPED software.	SELECT
[MCU VERSION]	Display the current MCU version information.	SELECT
[MPEG VERSION]	Display the current MPEG version information.	SELECT
[FACTORY SETTINGS]	Restore to default settings.	SELECT

VOLUME

1. Touch [Volume] to display the volume setting sub-menu.
 2. Touch to select a source to edit volume setting.
 3. Edit the volume setting, the volume range is from -12 to +12.
 4. Touch the upper left corner of the screen to exit.
- When choosing a source, the volume setting will change automatically to made setting.

TROUBLESHOOTING

NO POWER

Check the head unit to make sure it isn't damaged. If your system doesn't get any power, the most common issue is either in the wiring or the fuse. Use a multimeter to measure the head unit voltages, both yellow and red cable (+12-16V). Test to change position of the red & yellow cable in the harness.

Check that all speaker cables are connected to your sound system. If you are using a car specific cable harness, make sure it is for your car model. Most modern cars have some kind of CAN-Bus system to start the OEM head unit, for these cars a special CAN-Bus harness is needed. Make sure that the RCA cables are properly connected if external amplifier is used and that you have 12V remote on the external amplifier.

UNWANTED NOISE

Start by looking over the speakers in the sound system so there is no damage or connection issue with the wiring. Make sure that your signal cables or speaker cables aren't too close to the power cables. If the noise changes with the accelerator, it is most certain a ground loop issue. Make sure that the grounding point is good, especially if an external amplifier is used.

When all of the above has been tested/looked over, and the unwanted noise does not vanish, consult your local GAS dealer.

DISTORTION

Start by looking over the installation and all cables in the sound system so there's no damage or connection issue with the wiring. Check the speaker cables to make sure that the polarity isn't reversed on one channel. If an external amplifier is used, make sure that the gain/level is set according to the amplifier's instructions. If your amplifier has a boost function, lower its effect or turn it off.

GAS MAX MV240-BT have several audio settings, that used with none correct setting can make the setup, sound less good. Reset the settings as a last option.

NO VIDEO

Check that the camera is not covered by foreign objects. Make sure that the camera has all necessary 12 volt power. Check the reversing video signal cable. Make sure the reverse (pink cable into the head unit) is connected. Check if the reverse camera model is compatible or not with the head unit (If the picture can be mirrored).



WARRANTY & DISPOSAL

This product is covered by warranty, depending on the conditions in the country where it's sold. If the head unit is returned for service, please include the original dated receipt (or a copy) with the product. Make sure that the head unit is packaged properly and secured, preferably in its original packaging.



The crossed-out wheellie bin symbol means that the product, literature and packaging included must be taken to separate collection at the end of their working life. Don't dispose of these products as unsorted municipal waste: take them for recycling. For info on your nearest recycling point, check with your local waste authority.



This product has been granted with the CE certification mark to show that the product follows the health, safety, and environmental protection standards for products sold within the European Economic Area (EEA).



GAS Audio Power products comply with the relevant provisions of the RoHS Directive for the European Union. In common with all Electrical and Electronic Equipment (EEE) the product shouldn't be disposed of as household waste. Alternative arrangements may apply in other jurisdictions.



GAS Audio Power is a global partner of the European Mobile Media Association, an organization that focus on promoting the custom made mobile media installations to consumers.

THE GAS WORLD

You've entered the world of GAS. We aim to please, and we've made sure to have products made for you. No matter what stage of the LOUD-addiction you might find yourself in, there is a GAS product to fill your need.

MAD

Just starting out? The MAD series is made to play LOUD and to be the express lane to a no bullsh!t sound system that will make sure everyone can hear you coming!

MAX

The MAX series holds products made to deserve the center stage. Powerful, heavy duty and designed to be noticed. We made NO COMPROMISES because we know that you wouldn't accept it.

CMP

The CMP series has been developed for the crucial seconds when the dB-counter starts to tick. All CMP products have hand-picked, high quality, COMPETITION GRADE components and they are specially designed to withstand an awesome amount of power.



THANKS FOR JOINING GAS AUDIO POWER!



GAS
AUDIO POWER

GAS AUDIO POWER and SHAKY are registered trademarks by Winn Scandinavia AB and is protected by relevant laws and jurisdictions such as Copyright and Trademark laws.

Winn Scandinavia AB | Elementvägen 15, 70227 Örebro, Sweden | www.winnscandinavia.com

Winn Scandinavia AB reserves for possible typos, factual or numeric errors that may have been printed on any products, package designs, user manuals and/or other included accessories.

Winn Scandinavia AB can't guarantee flawless function/performance of our products together with third-party accessories and products like USB data carriers, MicroSD cards, cables, etc.







GAS

AUDIO POWER