

Owners Manual



FM/USB/BT/AUX RECEIVER



MODEL: GMA152BTR

www.gascaraudio.com

1. INTRODUCTION

Thank you for purchasing this GAS car audio product! We at GAS are committed to create great products for you by following our simple, yet powerful, premise: **Offer more, charge less!**

To ensure proper use of your purchased product, please carefully read through this manual before using the product. It is especially important that you read and observe caution's in this manual. Please keep the manual in a safe and accessible place for future reference.

2. TABLE OF CONTENT

1. Introduction.....	2
2. Table of content.....	2
3. Important information.....	2
4. Installation and wiring.....	3
5. Control panel layout and button locations.....	3
6. Remote control button locations.....	4
7. General operation.....	4
8. Trouble shooting.....	7
9. Specifications.....	7
10. Safety information.....	8

3. IMPORTANT INFORMATION

This unit is designed for 12V DC, negative ground operation only.

Carefully read through this manual before installation.

CAUTION! Do not adjust any settings, operate the GAS RC app or do anything that takes your attention away from safe driving!

Consult a professional car audio installer if you are not sure how to safely install the head unit.

As a precaution, disconnect the car battery ground cable before connecting the head unit. Do not block vents or radiator panels.

Follow the wiring connections in this manual to safely install the head unit. More safety information can be found on the last page of the manual.

4. INSTALLATION AND WIRING

STEP 1: Remove the mounting sleeve from the stereo.

STEP 2: Follow the wiring diagram when using the included ISO connector:

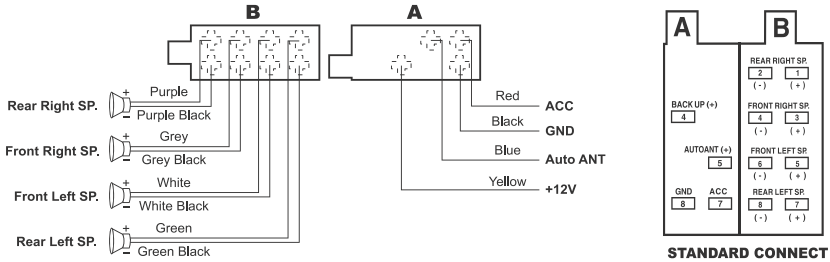

STEP 3: Additional inputs:

Ext. mic - Input for the included external microphone. Install the Microphone as close to your talking position as possible.

Antenna - Connect the car's FM/AM antenna.

1-4 RCA - Connectors for external amplifiers. Please read your amplifier's manual for installation instructions.

- ① Front RCA Output (R)/Red
- ② Front RCA Output (L)/White
- ③ Rear RCA Output (R)/Red
- ④ Rear RCA Output (L)/White

REAR OF CAR RADIO

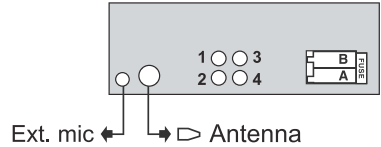

5. CONTROL PANEL LAYOUT AND BUTTON LOCATIONS

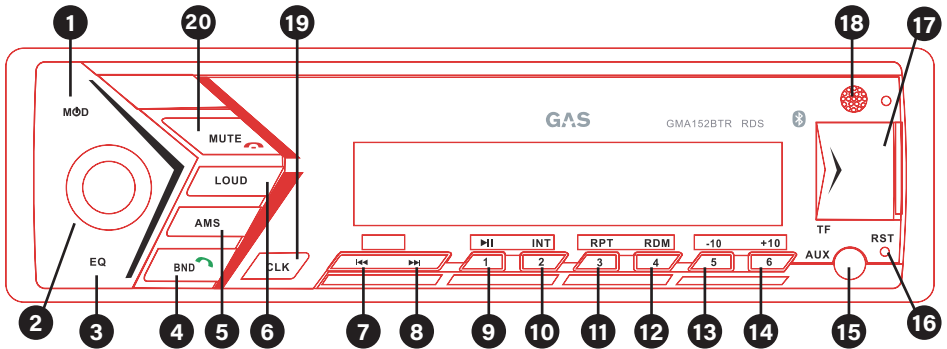

- 1: Power / Mode
- 2: Select / Toggle
- 3: EQ settings
- 4: BAND Radio Band selection (press)/ Answer phone call (press when call is active)
- 5: AMS Auto Scan and auto store radio channels
- 6: LOUD Loudness ON/OFF
- 7: Tune/seek down, previous track, fast reverse
- 8: Tune/seek up, next track, fast forward
- 9: Pre-set 1 / Play/Pause
- 10: INT Pre-set 2 / Play intro 10 sec.

- 11: RPT Pre-set 3 / Repeat track
- 12: RDM Pre-set 4 / Random play
- 13: 5/-10 Pre-set 5 / Previous 10 tracks, previous folder
- 14: 6/+10 Pre-set 6 / Next 10 tracks, next folder
- 15: AUX auxiliary input 3.5mm stereo jack
- 16: RST Reset head unit
- 17: TF USB/TF input
- 18: IR Remote control sensor
- 19: CLK Clock function
- 20: MUTE Mutes all sound (press)/ End phone call (press when call is active)

6. REMOTE CONTROL BUTTON LOCATIONS

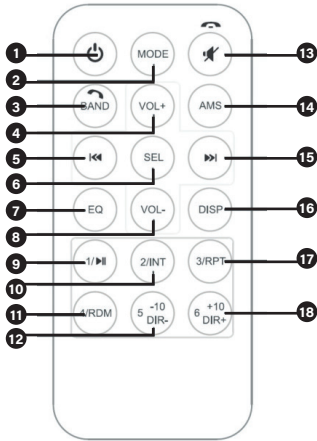

- 1: Power
- 2: MODE toggle / source
- 3: BAND Toggle band FM/AM (press), Answer phone call (press when call is active)
- 4: Volume +
- 5: Previous track
- 6: SEL Confirm selected function
- 7: EQ Toggle pre-EQ
- 8: Volume -
- 9: Pre-set 1 / Play/Pause
- 10: INT Pre-set 2 / Play intro 10 sec.
- 11: RDM Pre-set 4 / Random play
- 12: 5/-10 Pre-set 5 / Previous 10 tracks, previous folder
- 13: MUTE Mutes all sound (press), End phone call (press when call is active)
- 14: AMS Auto Scan and auto store radio channels
- 15: Next track
- 16: Press to shift between clock/radio station
- 17: RPT Pre-set 3 / Repeat track
- 18: 6/+10 Pre-set 6 / Next 10 tracks, next folder

7. GENERAL OPERATION

Power On/Off

Press the power button to turn the unit on, press and hold the power button to turn the unit off.

Main menu

Press the volume knob to display the menu. Turn the volume knob to toggle between functions, press the knob to make a selection.

Audio settings

Volume

To adjust the volume, turn the volume knob or use vol +/- on the remote control.

Treble/bass

Treble and bass levels can be adjusted from -7 to +7.

Fade

Fade between front and rear speakers, the level can be adjusted from -7 to +7.

Balance

Balance between left and right speakers, the level can be adjusted from -7 to +7.

Loudness

Turns the loudness function on/off.

EQ

Toggle on/off between pre-set EQ levels. POP, ROCK, JAZZ, CLASSIC.

Mute

Toggles mute on/off.

Radio settings

Automatic Scan

The AMS (Automatic Scan) button automatically scans and stores radio stations. Press and hold the AMS button for 3 seconds to start the scan and automatic memory function.

Press the AMS button to display the stored channels. The pre-set 1-6 for FM1, FM2, FM3 will flash for 10 seconds. To stop the scan press AMS again. To select a pre-set station, press the 1-6 buttons on the display or on the remote control.

Manual Scan

Press the forward button repeatedly to search station manually, press and hold forward button to search station automatically. To store the station, press and hold a selected 1-6 button until the frequency blinks in the display.

Band selection

Press BAND to toggle between FM1, FM2 and FM3.

Stereo / Mono

Toggles between Stereo/Mono radio.

Local / DX

Toggle selection. Local tunes in only the strongest closest signals for the selected station. DX tunes in to a wider range of stations.

RDS settings

Long press the volume knob to access RDS functions. Turn volume knob to toggle between functions, press volume knob to select function.

TA

Traffic announcements toggle on/off. While activated this function switches automatically between radio and incoming traffic announcements.

TA seek

Automatically searches for the strongest TA signals.

TA alarm

Alarm sound toggle on/off, activates with incoming TA announcements.

AF

Alternative frequencies toggle on/off. The unit automatically maintain station while switching between the strongest transmitters along current route.

PTY

Program Type toggle on/off. Allows the user to find similar radio programs by genre.

Display settings

The display colour can be toggled between Red, Yellow, White, Green, Cyan, Blue, Purple and Auto.

Bluetooth

Connection

1. Make sure Bluetooth is activated on your mobile device.
2. Toggle mode and select Bluetooth.
3. Enter default password 0000 on your mobile device to confirm connection.



Hands free

When receiving an incoming call, "calling" will appear on the display, press BND to answer, and press mute to end call. To repeat the latest call, press and hold BND.

Bluetooth audio

Operate the mobile Bluetooth device to start playback.

Bluetooth audio operation



1.  Play / Pause.
2.  Previous track, fast reverse .
3.  Next track, fast forward.

USB MP3 / WMA

Connection

1. Insert a USB memory stick, or a TF memory card.
2. USB/TF memory card playback starts automatically

USB audio operation

1.  Play / Pause.
2.  Previous track, fast reverse
3.  Next track, fast forward.
4. RPT Toggle on/off to repeat track
5. INT Toggle on/off to play intro 10sec
6. RDM Toggle on/off to play random track
7. DIR- /DIR+ on remote control to skip 10 tracks

AUX in

Connection

Use an auxiliary cable, 3.5mm stereo jack to connect external unit. Toggle mode to select AUX.

GAS RC Application

The GAS RC Control App connects and controls compatible GAS receivers via Bluetooth.

Key features include remote control, receiver setting and display information. Please consult App Store and Google play instructions for further instructions.

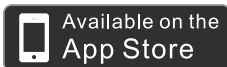

8. TROUBLE SHOOTING

Problem	Cause	Action
Unit will not turn on (no power)	Yellow wire not connected or incorrect voltage Red wire not connected or incorrect voltage	Check connections for proper voltage (12V DC)
	Black wire not connected	Check connection to ground
	Fuse blown	Replace fuse
Unit has power (but no sound)	Speaker wires not connected	Check connections at speakers
	One or more speaker wires are touching each other or touching chassis ground	Insulate all bare speaker wires from each other and the chassis ground.
Unit blows fuses	Yellow or red wire touching chassis ground	Check for pinched wire
	Speaker wires touching chassis ground	Check for pinched wire
	Incorrect fuse rating	Use fuse with correct rating
Excessive skipping	Unit is not mounted correctly or the back strap is not secure.	Check mounting sleeve and back strap support

9. SPECIFICATIONS

General

Power requirements:	12V DC
Load impedance:	4 Ohm
Tone controls:	+8dB (bass 10Hz, Treble 10KHz)
Current consumption:	15A MAX
Maximum Power Output:	50W x 4CH

Audio section

Maximum output level:	2V rms
Frequency response:	20Hz to 20KHz
Signal-to-noise ratio:	85dB
Separation:	80dB

FM tuner section

Tuning range:	87,5-108
IF range:	10,7MHz
Usable sensitivity (-30dB):	15dB
Usable-to-noise ratio:	60dB
Stereo separation:	30dB (1 KHz)
Frequency response:	30-15000 Hz

10. SAFETY INFORMATION

Safety notes

This car audio system was manufactured according to recommended and established safety guidelines in a state-of-the-art facility. Even so, dangers may occur if you do not observe the safety notes in these instructions.

These instructions are intended to familiarize you with the most important functions. Detailed information can be found by your local GAS dealer.

Read these instructions carefully and completely before using the car audio system.

Keep the instructions at a location so that they are always accessible to all users.

In addition, please consult the manuals to any external devices you connect to this car audio system to ensure functions and connections.

Road safety

Please read through these notes thoroughly about road safety.

Use your device in such a way that you can always safely control your vehicle. In case of doubt, stop at a suitable location and operate your device while the vehicle is parked.

Always listen at a moderate volume to protect your hearing and to be able to hear warning signals (e.g. sirens).

During mute phases (e.g. when changing the audio source), changing the volume is not advisable. Always respect your surroundings and follow your local regulations and laws regarding sound volume.

Do not modify or open the device

No user-removable parts inside, if the unit is damaged in any way, please consult your local GAS dealer for support. All service or repair should be carried out by a specialist.

This car audio system is intended for installation and operation in a vehicle with 12V negative ground only.

Installation

You may only install the car audio system yourself if you are experienced in installing car audio systems and if you are very familiar with the electrical system of the vehicle. For this purpose, observe the connection instructions in this manual.

Declaration of conformity

We declare that the device complies with the basic requirements and the other relevant regulations of the RED Directive 2014/53/EU.

Cleaning the unit

Solvents, cleaning and scouring agents as well as dashboard spray and plastic care products may contain ingredients that will damage the surface and display of the unit.

Use only a dry or slightly moistened cloth for cleaning the unit.

WARNING

The remote control is supplied with a coin / button cell battery. If this battery is swallowed, it can cause severe internal burns and can lead to death in 2 hours. Keep new, and used batteries away from children.

If the battery compartment does not close securely stop using the product and keep it away from children.

If you think batteries might have been swallowed or placed inside any part of the body, seek immediate medical attention.



All GAS Car Audio products complies with the relevant provisions of the RoHS Directive for the European Union. In common with all Electrical and Electronic Equipment (EEE) the GAS Car Audio product should not be disposed of as household waste. Alternative arrangements may apply in other jurisdictions.

The crossed-out wheeled bin symbol means that the product, literature and packaging included must be taken to separate collection at the end of their working life. Do not dispose of these products as unsorted municipal waste: take them for recycling. For info on your nearest recycling point, check with your local waste authority.

GAS
CAR AUDIO

www.gascaraudio.com

info@gascaraudio.com

Adolfsbergsvägen 6
702 27 Örebro, Sweden